

Applications

- Bottle Washing Machinery
- Steam Tables
- Plating Tanks
- Heating Ducts
- Fuel Oil Heaters
- Cooking Vats
- Heat Exchangers
- Induction Furnaces
- Industrial Compressors
- Cold Storage Boxes
- Cooling Ducts
- Engine Jacket Cooling
- Liquid Chillers
- Water Heaters
- Parts Washers

KOMBAT K1 Pneumatic Control Valve

**Pressures To 400 PSIG
Temperatures to 400°F**

KOMBAT K1
FEATURES

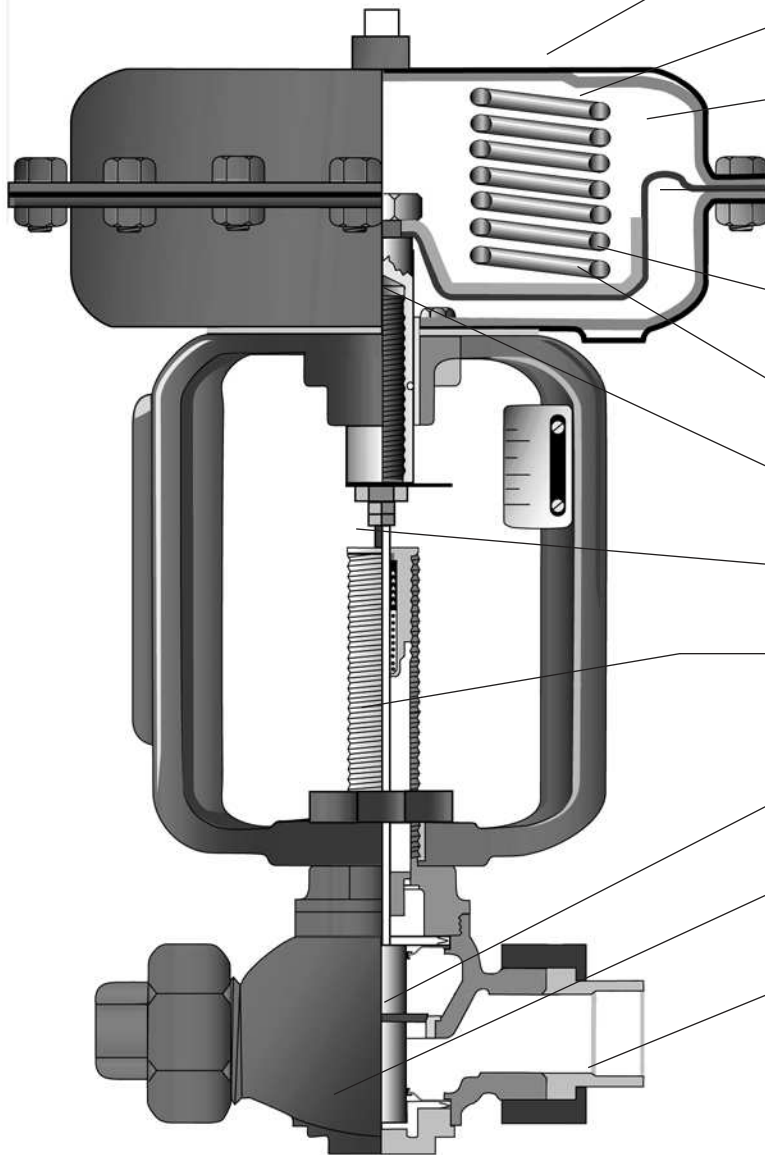

High-thrust Compact Actuator

offers the muscle required to positively position plug in response to control signal

Fixed Actuator 3-15 Spring Ranges

conform to standard controller outputs

36 and 60 sq. in. Actuator Sizes

with stainless steel internals match different operating conditions

Bolted Diaphragm Joint

for maximum strength, ease of maintenance and high-pressure tightness

Molded Reinforced Rolling Diaphragm

provides linearity of diaphragm loading pressure to valve travel for accuracy of control

Corrosion Protected Multiple Springs

for lower hysteresis and minimal deadband

Low Friction Actuator Design

for accurate repetitive positioning

Low Friction Burnished Stem

provides precise control and long life

Spring Loaded Chevron Type Packing Assembly

eliminates leakage which reduces maintenance

Erosion Resistant Stainless Steel Seat Rings and Disc

for precise flow control and long life

High Capacity Bronze Body

minimizes turbulence and pressure drop

Galvanized Iron Union Ends

for easy installation



KOMBAT K1 CONTROL VALVE

KOMBAT SERIES K CONTROL VALVE

SIZES 1/2" – 4"
ANSI Class 125/250

- **Shutoff to 400 PSI without Positioner** for broad range of applications.
- **Ultra Compact Multi-spring Pneumatic Actuator** installs in tight spaces.
- **3–15 lb. Spring Ranges** in durable epoxy coated pneumatic actuators accommodate most standard input devices.
- **Powerful Electric Actuator** accepts a wide variety of signals while providing highest shutoff in it's class.
- **Live Loaded V ring Packing Assembly** is self adjusting.
- **Stainless Steel Valve Plugs & Seat Rings** resist wear and corrosion
- **Optional 3-Way Body** for mixing or diverting

APPLICATION DATA

- Process control systems for food, pulp and paper, chemical, petrochemical & other industries
- HVAC systems
- Feed water and fuel system controls in boiler rooms
- Packaged systems (OEM) such as heat exchangers, water purification systems & vaporizer, metal cleaning and plating
- Mixing or diverting applications

PRESSURE/TEMPERATURE CHART

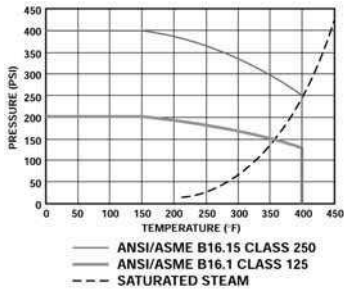

MODELS

- Type K1 — Single Seat Bronze w/union ends & Pneumatic Actuator
- Type K3 — 3-Way Bronze w/union ends & Pneumatic Actuator
- Type K4 — Single Seat Flanged Cast Iron w/Pneumatic Actuator
- Type K5 — Same as K1 w/Electric Actuator, fail closed
- Type K6 — Same as K1 w/Electric Actuator, fail open
- Type K7 — Same as K3 w/Electric Actuator

OPTIONS

- 36 or 60 sq. in. Pneumatic Actuator
- Electric Actuator

APPLICABLE CODES

- Meets or exceeds ANSI B16.15 Class 250 or ANSI B16.1 Class 125
- ANSI/FCI 70-2 Class IV Seat Leakage

PLUG CHARACTERISTICS

Modified Equal Percent, 30:1 flow rangeability

KOMBAT SERIES K VALVE ORDERING CODE

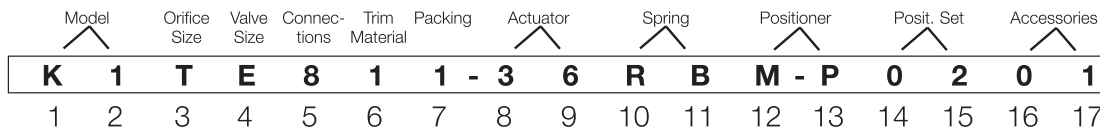

Model -
Position 1 & 2
K1 = Bronze, Pneumatic
K3 = Bronze, 3 Way, Pneumatic
K4 = Cast Iron, Pneumatic
K5 = Bronze, Electric, FC
K6 = Bronze, Electric, FO
K7 = Bronze, 3 Way, Electric

Orifice Size -
Position 3
A
B
C
E
T

Valve Size -
Position 4
C = 1/2
D = 3/4
E = 1
F = 1 1/4
G = 1 1/2
H = 2
J = 2 1/2
K = 3
M = 4

Connections -
Position 5
2 = 125 Flg
8 = Unions

Trim Material -
Position 6
1 = Metal

Packing -
Position 7
1 = V-ring

Actuator -
Position 8 & 9
K1, K3, K4 only
01 = None
36 = 36 sq. in.
60 = 60 sq. in.
K5, K6, K7 only
90 = 0-10vDC
91 = 4-20mA
92 = 0-135ohm

Spring -
Position 10 & 11
All except K4
DA = Dir 36
DC = Dir 36
DD = Dir 36
DG = Dir 60
FM = Dir 36
RA = Rev 36
RB = Rev 36
RC = Rev 36
RD = Rev 36
RE = Rev 36
DF = Dir 60
DG = Dir 60
RG = Rev 60
K4 only
DH = Dir 60
RH = Rev 60
RQ = Rev 60
RT = Rev 60

Positioner -
Position 12 & 13
A = None
MI = Moore I/P
MP = Moore P
4P = PMV P4 P
5I = PMV P5 I/P
5P = PMV P5 P

Positioner Set
Position 14 & 15
01 = None
02 = 8-15/4-20 mA
03 = 3-9/4-12 mA
04 = 9-15/12-20 mA

Accessories -
Position 16 & 17
01 = None
02 = Limit Switch, Mechanical
03 = Limit Switch, Proximity Sw.
04 = Feedback Potentiometer 1K
05 = Feedback 4-20mA Posit. Tra

KOMBAT SERIES K CONTROL VALVE

SPECIFICATION

Valve shall be pneumatically or electrically actuated, have a bronze or cast iron body and meet ANSI B16.15 Class 250 or ANSI B16.1 Class 125 accommodating pressures to 400 PSIG. Guiding shall be low friction utilizing spring loaded self adjusting chevron type teflon packing, burnished stem and double guided stainless steel monolithic disc assembly. Valve trim shall be erosion resistant stainless steel with a modified equal percent flow characteristic capable of exceeding ANSI/FCI 70-2 Class IV shut off. Valve connections shall be female NPT with integral galvanized cast iron unions or flanged. Pneumatic actuator shall be 36 sq. in. or 60 sq. in. and have a high thrust multi spring diaphragm. Actuator components shall be stainless steel and epoxy coated. Fixed 3-15 pound springs shall be utilized to accommodate standard controller outputs without a positioner. The electric actuator shall accept 0-10 VDC, 4-20 mA or 0-135 ohm input signal. Spring shall return to initial position on loss of signal. Actuator shall have manual override. It shall close to 400 psi. Enclosure shall meet NEMA 1.

MATERIALS OF CONSTRUCTION

Body K1, K3, K5, K6, K7Bronze ASTM B62
 K4Cast Iron ASTM A126 CL B
 Bonnet K4DI ASTM A536 65-45-12
 Seat K1, K3, K5, K6, K7303 SS ASTM A276
 K4420 SS ASTM A743
 Plug/Stem Assy K1, K3, K5, K6, K7303 SS ASTM A276
 Plug K4420 SS ASTM A743
 Stem303SS ASTM A582
 Stem Guide - Body K1, K3, K5, K6, K7 ...301 SS/Monel/Brass
 Live Loaded PackingPTFE/302 SS Spring/Viton O-Ring
 Actuator Casing K1, K3, K4 ...Steel SAE 1006 - 1008/Epoxy
 K5, K6, K7Powder Coated Aluminum
 Actuator Spring K1, K3, K4Music Wire ASTM A228
 Diaphragm K1, K3, K4Nitrile/Polyester
 Yoke K1, K3, K4D Iron ASTM A536/Epoxy
 K5, K6, K7Powder Coated Aluminum

MAXIMUM RATED FLOW COEFFICIENTS* (Cv)

VALVE	VALVE SIZE								
	1/2	3/4	1	1 1/4	1 1/2	2	2 1/2	3	4
2-WAY	5.2	7	11	20	25	30	71	94	146
3-WAY	5.4	6.4	8.7	19.5	24	34	—	—	—

*See Flow Characteristic Chart on following pages.

K1, K4, K5 & K6 DIMENSIONS inches (mm) AND WEIGHTS pounds (kg)

Size	A	B	C	Weight		
				K1, K4 36 in ²	K1, K4 60 in ²	K5, K6
1/2-3/4 (15)-(20)	5 1/2 (140)	11 1/16 (43)	1 1/16 (30)	21 (9.5)	—	13 (6)
1 (25)	7 7/16 (183)	2 7/8 (74)	2 5/16 (58)	25 1/2 (11.6)	39 (17)	17 1/2 (8)
1 1/4-1 1/2 (32)-(40)	8 7/8 (226)	3 3/8 (79)	2 7/8 (74)	31 1/2 (14.3)	45 (20)	23 1/2 (11)
2 (50)	8 7/8 (226)	3 3/8 (79)	2 7/8 (74)	33 3/8 (15.2)	47 (21)	25 1/2 (12)
2 1/2 (65)	9 7/8 (238)	5 1/4 (133)	3 3/8 (118)	—	72 (33)	—
3 (80)	10 (254)	6 3/8 (155)	4 3/8 (136)	—	84 (39)	—
4 (100)	11 7/8 (302)	7 1/4 (181)	6 1/2 (187)	—	145 (66)	—

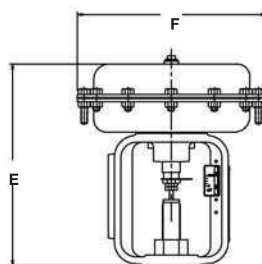

K1, K3, K4 ACTUATOR

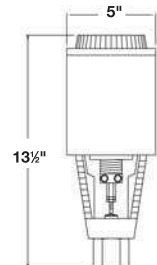

K5, K6, K7 ACTUATOR

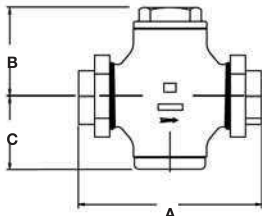

K1, K5 1/2" - 2"

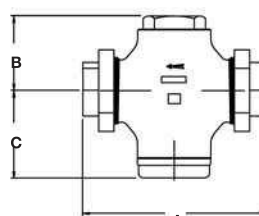

K6 1/2" - 2"

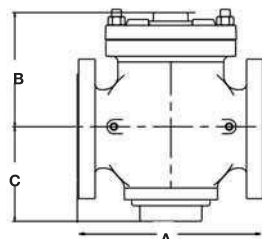

K4 2 1/2" - 4"

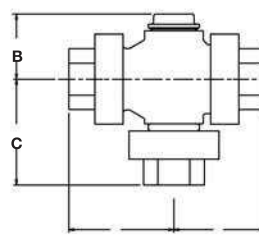

K3, K7 1/2" - 2"

PNEUMATIC ACTUATOR DIMENSIONS inches (mm)

Size	E		F	
	36 in ²	60 in ²	36 in ²	60 in ²
1/2-3/4 (15)-(20)	9 7/8 (251)	—	9 3/4 (235)	—
1 (25)	9 7/8 (251)	11 1/4 (298)	9 3/4 (235)	11 1/4 (286)
1 1/4-1 1/2 (32)-(40)	9 7/8 (251)	11 1/4 (298)	9 3/4 (235)	11 1/4 (286)
2 (50)	9 7/8 (251)	11 1/4 (298)	9 3/4 (235)	11 1/4 (286)
2 1/2 (65)	—	11 1/4 (302)	—	11 1/4 (286)
3 (80)	—	11 1/4 (302)	—	11 1/4 (286)
4 (100)	—	11 1/4 (302)	—	11 1/4 (286)

K3, K7 DIMENSIONS inches (mm) AND WEIGHTS pounds (kg)

Size	A	B	C	D	Weight	
					36 in ²	60 in ²
1/2-3/4 (15)-(20)	3 3/8 (92)	3 3/16 (84)	4 1/8 (105)	2 7/8 (73)	28 (13)	—
1 (25)	3 3/8 (92)	3 3/16 (84)	4 1/8 (105)	2 7/8 (73)	28 (13)	—
1 1/4 (32)	4 1/16 (119)	4 1/8 (105)	4 1/16 (119)	3 3/8 (79)	35 (16)	48 (22)
1 1/2 (40)	4 1/16 (119)	4 1/8 (105)	4 1/16 (119)	3 3/8 (79)	37 (17)	50 (23)
2 (50)	4 7/8 (124)	4 3/8 (106)	4 5/8 (125)	3 3/8 (79)	42 (19)	55 (25)

Control Tip: Pair with Airmaster Pneumatic Temperature Controller for local temperature control. SEE PAGE 79.

Control Tip: Install with Model 65A Air Filter Regulator to convert plant air to instrument quality air. SEE PAGE 169.

KOMBAT SERIES K
CONTROL VALVES

K1, K4, K5, K6 ACTUATOR SHUTOFF TABLE

(Refer to Temperature Limits)

KOMBAT SERIES K
CONTROL VALVES

Size	Orifice	Act. Size	Bench Range	Actuator Code	Reverse Shutoff, K1,K4*			Bench Range	Actuator Code	Direct Shutoff, K1,K4*			Shutoff, K5,K6	
					3-15 psi	0-20 psi†	0-30 psi‡			3-15 psi	0-20 psi†	0-30 psi‡		
1/2	A, C, E	36	6-15	RA	400	400	—	3-12	DA	400	400	—	400	
	B	36	6-15	RA	400	400	—	3-12	DA	300	400	—		
	—	—	—	—	—	—	—	3-9	DB	400	400	—		
3/4	T	36	6-15	RA	100	300	—	3-9	DB	250	400	—	400	
			9-15	RR	225	350	—	—	—	—	—	—		
			12-15	RC	300	400	—	—	—	—	—	—		
1	T	36	12-15	RC	250	400	—	—	—	—	—	—	330	
			13-15	RE	400	400	—	—	—	—	—	—		
			60	—	—	—	—	—	3-7	DG	400	400		—
1 1/4	T	36	9-15	RB	150	175	—	3-9	DR	150	250	—	210	
			12-15	RC	200	250	—	—	—	—	—	—		
			13-15	RE	250	275	—	—	—	—	—	—		
			60	12-15	RG	300	400	—	3-7	DG	300	400		—
			13-15	RH	400	400	—	—	—	—	—	—		—
1 1/2	T	36	12-15	RC	150	225	—	—	—	—	—	—	161	
			13-15	RE	200	250	—	—	—	—	—	—		
			60	12-15	RG	225	275	—	3-7	DG	200	400		—
			13-15	RH	275	300	—	—	—	—	—	—		—
2	T	36	12-15	RC	50	75	—	—	—	—	—	—	121	
			13-15	RE	75	100	—	—	—	—	—	—		
			60	12-15	RG	125	200	—	3-7	DG	100	300		—
			13-15	RH	175	250	—	—	—	—	—	—		—
2 1/2	T	60	10-15	RH	75	—	100	3-8	DH	70	—	200	—	
			12-15	RQ	125	—	125	3-8	DH	70	—	200		
			22-30	RT	—	—	125	3-8	DH	70	—	200		
3	T	60	10-15	RH	40	—	60	3-8	DH	40	—	100	—	
			12-15	RQ	60	—	80	3-8	DH	40	—	100		
			22-30	RT	—	—	110	3-8	DH	40	—	100		
4	T	60	12-15	RQ	20	—	32	3-8	DH	10	—	25	—	
			22-30	RT	—	—	50	3-8	DH	10	—	25		

* Shutoff pressures are in conformance with ANSI/FCI 70-2 Class IV
Reverse Acting - Fail Closed/Air to Open (FC/ATO)
Direct Acting - Fail Open/Air to Close (FO/ATC)

† Based on 20 psi air supply.
‡ Based on 30 psi air supply.

K1, K4, K5, K6 Cv TABLE

PERCENT OF TRAVEL			5	10	20	30	40	50	60	70	80	90	100
Valve Size	Travel	Orifice	Cv										
1/2	1/4	C	0.1	0.2	0.3	0.36	0.41	0.46	0.51	0.56	0.6	0.65	0.7
		E	0.3	0.5	0.7	0.9	1.1	1.3	1.5	1.7	1.9	2	2.1
		A	0.3	0.6	1.2	1.7	2.2	2.6	2.9	3.1	3.2	3.25	3.3
		B	0.15	0.25	0.65	1.5	2.7	3.3	3.7	3.9	4.1	4.2	4.3
		T	0.7	1.2	2.0	2.7	3.2	3.8	4.3	4.7	4.9	5.1	5.2
3/4	5/16	T	0.7	1.3	2.4	3.3	4.2	4.9	5.5	6.0	6.4	6.8	7.0
1	1/4	T	0.7	1.3	2.4	3.8	5.5	7.4	9.0	10.0	10.6	10.9	11.0
1-1/4	5/16	T	0.8	1.7	4.0	6.5	9.3	12.6	15.3	17.0	18.1	19.1	20.0
1-1/2	5/16	T	1.0	2.0	4.5	7.2	9.9	12.4	15.2	18.2	20.9	23.4	25.0
2	5/16	T	1.0	2.0	4.5	7.4	10.6	15.1	18.8	22.8	26.1	28.3	30.0
2-1/2	3/4	T	5	11	23	36	46	53	59	62.5	65.7	68	71
3	3/4	T	5	11	30	47	61	72	79	85	90	92	94
4	3/4	T	12	23	46	69	89	104	116	127	134	140	146



K3, K7 ACTUATOR SHUTOFF TABLE

(Refer to Temperature Limits)

Size	Act. Size	Bench Range	Actuator Code	K3 Reverse Shutoff*		Bench Range	Actuator Code	K3 Direct Shutoff**		K7 Shutoff
				3-15 psi	0-20 psi			3-15 psi	0-20 psi	
				1/2	36			5.5 - 12.5 6.5 - 11.5 8 - 11	RA RB RC	
3/4	36	5.5 - 12.5 6.5 - 11.5 8 - 11	RA RB RC	125 175 250	300 375 400	4.5 - 13.5 6 - 12 -	DM DA -	85 175 -	400 400 -	400
1	36	5.5 - 12.5 6.5 - 11.5 8 - 11	RA RB RC	75 125 200	200 250 300	4.5 - 13.5 6 - 12 -	DM DA -	60 125 -	250 300 -	295
1 1/4	36	5.5 - 12.5	RC	60	125	6 - 12	DC	80	200	185
		7.5 - 10.5	RE	110	200	7 - 11	DD	100	225	
		7.5 - 12	RG	200	300	7 - 11	DG	175	XX	
1 1/2	60	7.5 - 12	RH	225	350	-	-	-	-	145
		5.5 - 12.5	RC	50	100	6 - 12	DC	60	150	
		7.5 - 10.5	RE	85	150	7 - 11	DD	75	175	
2	36	7.5 - 12	RG	125	250	7 - 11	DG	135	XX	105
		8 - 11	RH	175	275	-	-	-	-	
		5.5 - 12.5	RC	35	75	6 - 12	DC	45	100	
60	7.5 - 10.5	RE	70	100	7 - 11	DD	60	135	105	
		7.5 - 12	RG	75	175	7 - 11	DG	100		XX
		8 - 11	RH	125	200	--	-	-		-

* Lower Part (B) Fail Closed

** Upper Part (A) Fail Closed

KOMBAT SERIES K CONTROL VALVES

K3, K7 C_v TABLE

PERCENT OF TRAVEL			0	10	20	30	40	50	60	70	80	90	100
Valve Size	Travel (In)	Port	C _v										
1/2	7/32	Lower	0	0.9	1.9	2.7	3.6	4.3	4.8	5.2	5.3	5.35	5.4
		Upper	5.6	5.55	5.5	5.3	4.9	4.5	3.9	3.1	2.2	1.2	0
3/4	7/32	Lower	0	0.9	2	3	4	4.9	5.5	6	6.2	6.3	6.4
		Upper	7.1	7	6.9	6.5	5.9	5.2	4.4	3.4	2.3	1.2	0
1	7/32	Lower	0	0.8	1.7	2.9	4	5.3	6.2	7.2	7.8	8.4	8.7
		Upper	9.2	8.5	7.9	7.1	6.2	5.3	4.2	3.2	2.1	1.1	0
1-1/4	1/2	Lower	0	2.7	6.2	10.2	15	18.8	20	20.8	21.2	21.6	22
		Upper	19.5	19	18.5	17.5	15.5	13.5	11	8	5	2.5	0
1-1/2	1/2	Lower	0	2	6	11	16	20	22.5	24.5	26	27	28
		Upper	24	23	22	20	18	15	12	9	6	2.7	0
2	1/2	Lower	0	2.2	5.7	10.9	16	21	24	27.4	30	32	34
		Upper	35	32.4	30	27	23.5	20	16	12	8	4	0

K3, K7 OPERATION

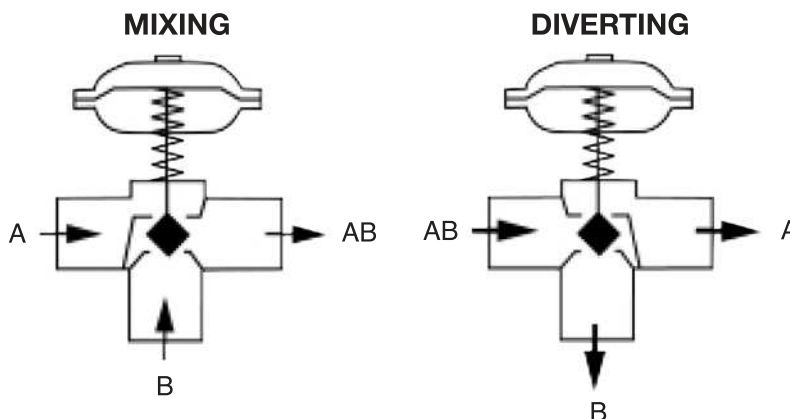

When used for mixing service, the forces developed by the two inlet flows oppose each other, creating little, if any, unbalance. Thus, the actuator can control the flow efficiently with very little power lost in overcoming dynamic unbalance. When used for diverting service, simply reverse the valve installation.

K1, K4, K5, K6 SATURATED STEAM CAPACITY TABLE

(Modified Equal Percent Contour Plug) (Lb/Hr)

KOMBAT STEAM
CAPACITY TABLE

Pressure (PSI)		Valve Size and Port												
P1	P2	1/2" C	1/2" E	1/2" A	1/2" B	1/2" T	3/4"	1"	1-1/4"	1-1/2"	2"	2-1/2"	3"	4"
10	5	22	65	102	133	161	217	341	620	775	930	2237	2962	4601
	0	27	81	128	166	201	270	425	773	966	1159	2846	3768	5853
15	10	24	72	114	148	179	241	379	689	861	1033	2477	3280	5094
	5	31	92	145	189	229	308	484	880	1099	1319	3216	4257	6613
	0	34	101	159	207	250	337	529	962	1202	1443	3586	4748	7374
20	15	26	79	124	161	195	262	412	750	937	1125	2692	3565	5537
	10	34	102	161	209	253	341	536	974	1217	1461	3543	4691	7286
	0	40	119	187	243	294	396	623	1132	1416	1699	4262	5643	8765
30	25	30	90	142	184	223	300	472	858	1072	1287	3072	4067	6316
	15	46	137	215	280	338	455	715	1301	1626	1951	4755	6295	9778
	0	51	152	239	312	377	507	797	1450	1812	2174	5525	7315	11362
40	25	52	156	245	319	385	519	815	1482	1852	2223	5384	7128	11071
	15	59	178	280	365	442	595	935	1699	2124	2549	6297	8337	12948
	0	62	185	290	378	457	615	967	1758	2198	2637	6724	8903	13827
50	35	57	172	271	353	427	575	903	1643	2053	2464	5943	7869	12222
	30	63	190	299	389	470	633	995	1809	2262	2714	6596	8732	13563
	25	67	202	318	414	501	674	1059	1925	2406	2888	7076	9368	14550
	2-0	72	217	341	444	537	723	1136	2066	2582	3099	7905	10466	16256
60	45	63	188	295	384	464	625	982	1786	2232	2679	6444	8531	13250
	40	69	208	327	426	515	693	1090	1981	2477	2972	7194	9524	14792
	35	74	223	351	457	552	744	1169	2125	2656	3187	7767	10282	15971
	4-0	83	249	391	509	616	829	1303	2370	2962	3555	9067	12005	18645
75	55	77	232	365	476	575	774	1216	2212	2765	3318	7996	10587	16443
	50	84	251	395	514	622	837	1315	2391	2989	3587	8690	11505	17870
	45	89	266	417	544	658	885	1391	2530	3162	3795	9246	12241	19013
	8-0	99	296	466	607	734	988	1552	2822	3527	4233	10797	14294	22202
100	75	97	291	457	596	721	970	1525	2773	3466	4159	10020	13266	20604
	60	113	340	534	696	841	1133	1780	3236	4045	4854	11845	15683	24358
	15-0	125	375	589	767	927	1249	1962	3567	4459	5351	13649	18071	28068
125	100	109	326	512	667	806	1086	1706	3102	3877	4652	11169	14787	22968
	75	138	413	649	845	1022	1376	2163	3933	4916	5899	14409	19077	29630
	21-0	151	452	710	925	1119	1507	2367	4304	5381	6457	16470	21806	33869
150	125	119	356	560	730	882	1188	1866	3394	4242	5090	12192	16142	25071
	100	153	460	723	943	1140	1535	2412	4385	5481	6577	15975	21150	32850
	28-0	176	529	831	1082	1309	1762	2769	5035	6293	7552	19264	25505	39614
175	150	128	384	604	787	951	1281	2013	3659	4574	5489	13124	17376	26988
	125	168	503	791	1030	1246	1677	2635	4791	5989	7187	17388	23021	35755
	100	189	567	891	1161	1403	1889	2969	5398	6747	8097	19859	26293	40838
	35-0	202	605	951	1239	1498	2016	3168	5761	7201	8641	22031	29168	45304
200	150	181	542	852	1110	1342	1806	2839	5161	6452	7742	18677	24728	38407
	125	206	618	971	1265	1529	2059	3235	5882	7353	8823	21533	28509	44279
	41-0	227	681	1069	1393	1685	2268	3565	6481	8101	9722	24799	32833	50996
225	175	193	578	908	1183	1430	1925	3025	5500	6875	8250	-	-	-
	150	221	664	1043	1359	1644	2213	3478	6323	7904	9485	-	-	-
	48-0	252	755	1187	1547	1870	2518	3956	7194	8992	10790	-	-	-
250	200	204	611	960	1251	1512	2036	3199	5817	7271	8725	-	-	-
	150	256	769	1208	1574	1904	2563	4027	7322	9153	10984	-	-	-
	100	275	825	1297	1690	2044	2752	4324	7862	9827	11792	-	-	-
	54-0	277	830	1304	1699	2055	2766	4346	7902	9878	11854	-	-	-

- It is recommended to keep valve outlet velocity below 30,000 ft./min.
- Capacities based on maximum Cv.

K1, K4, K5, K6 SATURATED STEAM CAPACITY TABLE

(Modified Equal Percent Contour Plug) (Kg/Hr)

Pressure (bar)		Valve Size and Port												
P1	P2	1/2" C	1/2" E	1/2" A	1/2" B	1/2" T	3/4"	1"	1-1/4"	1-1/2"	2"	2-1/2"	3"	4"
0.7	0.3	10	31	49	64	78	104	164	298	373	447	1079	1429	2220
	0.2	11	34	53	69	84	113	177	322	402	483	1171	1551	2409
1	0.7	10	31	48	63	76	102	161	292	365	438	1049	1389	2157
	0.5	12	37	59	76	92	125	196	356	445	534	1289	1707	2651
	0.3	14	42	65	85	103	139	218	396	495	594	1448	1918	2978
1.5	1	14	43	67	87	106	142	224	407	508	610	1467	1942	3017
	0.7	17	50	79	103	124	167	263	479	598	718	1746	2312	3591
	0.5	18	53	84	109	132	178	280	508	635	762	1870	2476	3846
2	1.5	16	47	74	97	117	157	247	449	562	674	1616	2139	3323
	1.2	19	56	88	115	139	188	295	536	670	804	1945	2575	3999
	1	20	60	95	124	149	201	316	575	719	862	2100	2781	4319
3	2	24	73	114	149	180	242	381	692	865	1038	2508	3321	5158
	1.0	29	87	137	179	216	291	457	832	1040	1248	3098	4102	6371
	0	32	97	152	198	239	322	506	920	1149	1379	3264	4322	6713
3.5	3.0	20	59	92	120	145	195	307	558	698	838	2000	2647	4112
	2.0	30	89	140	182	221	297	466	848	1060	1272	3099	4103	6373
	1.0	33	99	155	202	245	329	518	941	1176	1412	3531	4675	7261
	.1-0	36	108	170	222	268	361	567	1031	1289	1547	3661	4847	7528
4	3.0	28	83	130	169	204	275	432	786	983	1179	2836	3755	5832
	2.0	34	103	162	211	255	344	540	982	1228	1473	3615	4786	7433
	1.0	37	110	172	224	271	365	574	1044	1305	1566	3942	5219	8105
	.3-0	39	118	186	242	293	394	620	1126	1408	1690	4000	5296	8225
5	4.0	30	91	144	187	226	305	479	870	1088	1306	3131	4145	6438
	3.0	39	117	184	239	290	390	612	1113	1392	1670	4069	5387	8367
	2.0	43	128	201	262	317	427	671	1220	1525	1830	4544	6016	9344
	.6-0	47	140	220	287	347	467	734	1334	1667	2001	4757	6299	9783
7	5.0	47	140	221	288	348	468	736	1338	1672	2007	4848	6419	9970
	3.0	56	169	265	346	418	563	884	1607	2009	2411	5987	7926	12311
	1.0-0	62	187	293	382	462	622	978	1778	2222	2667	6311	8356	12978
9	7.0	53	160	252	328	397	534	839	1526	1907	2289	5505	7289	11321
	5.0	67	200	314	410	496	667	1048	1906	2382	2859	7015	9288	14425
	1.6-0	77	230	361	470	569	765	1203	2187	2733	3280	7762	10277	15962
10	8.0	56	168	265	345	417	562	882	1605	2006	2407	5780	7652	11885
	5.0	75	224	353	459	556	748	1175	2137	2671	3205	7916	10480	16277
	1.8-0	84	251	395	515	623	838	1317	2395	2994	3592	8502	11256	17483
12	10.0	62	185	291	379	458	616	968	1761	2201	2641	6327	8376	13009
	7.0	85	254	399	520	629	846	1330	2418	3023	3627	8886	11764	18272
	5.0	90	270	425	553	669	900	1415	2573	3216	3859	9633	12753	19808
	2.4-0	98	294	462	602	728	979	1539	2798	3498	4197	9939	13158	20438
14	10.0	87	261	410	535	647	871	1368	2488	3110	3732	-	-	-
	5.0	104	312	491	640	774	1041	1636	2975	3719	4463	-	-	-
	2.9-0	112	337	530	691	835	1124	1767	3213	4016	4819	-	-	-
15	12.0	81	243	383	499	603	812	1275	2319	2898	3478	-	-	-
	5.0	111	332	521	679	821	1105	1737	3158	3948	4737	-	-	-
	3.1-0	120	359	564	734	888	1195	1878	3415	4269	5123	-	-	-
17	15.0	73	219	344	448	542	730	1147	2086	2607	3129	-	-	-
	10.0	115	346	544	709	858	1155	1815	3300	4125	4950	-	-	-
	5.0	127	380	597	778	941	1266	1990	3619	4523	5428	-	-	-
	3.7-0	133	400	629	819	990	1333	2095	3809	4762	5714	-	-	-

KOMBAT STEAM
CAPACITY TABLE

- It is recommended to keep valve outlet velocity below 30,000 ft./min.
- Capacities based on maximum Cv.

K1, K4, K5, K6 WATER CAPACITY TABLE

(Modified Equal Percent Contour Plug) (G.P.M.)

KOMBAT WATER CAPACITY TABLE

Pressure (PSI)		Valve Size and Port												
P1	P2	1/2" C	1/2" E	1/2" A	1/2" B	1/2" T	3/4"	1"	1-1/4"	1-1/2"	2"	2-1/2"	3"	4"
10	5	2	5	7	10	12	16	25	45	56	67	159	210	326
	3	2	6	9	11	14	19	29	53	66	79	188	249	386
15	10	2	5	7	10	12	16	25	45	56	67	159	210	326
	7	2	6	9	12	15	20	31	57	71	85	201	266	413
20	4	2	7	11	14	17	23	36	66	83	99	235	312	484
	15	2	5	7	10	12	16	25	45	56	67	159	210	326
30	10	2	7	10	14	16	22	35	63	79	95	225	297	462
	5	3	8	13	17	20	27	43	77	97	116	275	364	565
40	22	2	6	9	12	15	20	31	57	71	85	201	266	413
	17	3	8	12	16	19	25	40	72	90	108	256	339	526
50	6	3	10	16	21	25	34	54	98	122	147	348	461	715
	25	3	8	13	17	20	27	43	77	97	116	275	364	565
60	20	3	9	15	19	23	31	49	89	112	134	318	420	653
	8	4	12	19	24	29	40	62	113	141	170	402	532	826
75	35	3	8	13	17	20	27	43	77	97	116	275	364	565
	30	3	9	15	19	23	31	49	89	112	134	318	420	653
80	25	4	11	17	22	26	35	55	100	125	150	355	470	730
	10	4	13	21	27	33	44	70	126	158	190	449	595	923
90	50	2	7	10	14	16	22	35	63	79	95	225	297	462
	40	3	9	15	19	23	31	49	89	112	134	318	420	653
100	25	4	12	20	25	31	41	65	118	148	177	420	556	864
	12	5	15	23	30	36	48	76	139	173	208	492	651	1012
110	70	2	5	7	10	12	16	25	45	56	67	159	210	326
	50	4	11	17	22	26	35	55	100	125	150	355	470	730
120	25	5	15	23	30	37	49	78	141	177	212	502	665	1032
	15	5	16	26	33	40	54	85	155	194	232	550	728	1131
130	75	4	11	17	22	26	35	55	100	125	150	355	470	730
	60	4	13	21	27	33	44	70	126	158	190	449	595	923
140	20	6	19	30	38	47	63	98	179	224	268	635	841	1306
	100	4	11	17	22	26	35	55	100	125	150	355	470	730
150	75	5	15	23	30	37	49	78	141	177	212	502	665	1032
	24	7	21	33	43	52	70	111	201	251	301	714	945	1467
160	125	4	11	17	22	26	35	55	100	125	150	355	470	730
	100	5	15	23	30	37	49	78	141	177	212	502	665	1032
170	29	8	23	36	47	57	77	121	220	275	330	781	1034	1606
	150	4	11	17	22	26	35	55	100	125	150	355	470	730
180	125	5	15	23	30	37	49	78	141	177	212	502	665	1032
	100	6	18	29	37	45	61	95	173	217	260	615	814	1264
190	34	8	25	39	51	62	83	131	237	297	356	843	1116	1734
	150	5	15	23	30	37	49	78	141	177	212	502	665	1032
200	100	7	21	33	43	52	70	110	200	250	300	710	940	1460
	39	9	27	42	55	66	89	140	254	317	381	901	1193	1853
210	175	5	15	23	30	37	49	78	141	177	212	-	-	-
	100	8	23	37	48	58	78	123	224	280	335	-	-	-
220	43	9	28	45	58	70	94	148	270	337	405	-	-	-
	200	5	15	23	30	37	49	78	141	177	212	-	-	-
230	150	7	21	33	43	52	70	110	200	250	300	-	-	-
	100	9	26	40	53	64	86	135	245	306	367	-	-	-
240	48	10	30	47	61	74	99	156	284	355	426	-	-	-
	250	5	15	23	30	37	49	78	141	177	212	-	-	-
250	150	9	26	40	53	64	86	135	245	306	367	-	-	-
	58	11	33	51	67	81	109	171	311	389	467	-	-	-
260	350	5	15	23	30	37	49	78	141	177	212	-	-	-
	200	10	30	47	61	74	99	156	283	354	424	-	-	-
270	77	13	38	59	77	93	126	198	359	449	539	-	-	-

- It is recommended to keep valve outlet velocity below 30,000 ft./min.
- Capacities based on maximum Cv.



K1, K4, K5, K6 WATER CAPACITY TABLE

(Modified Equal Percent Contour Plug) (M3/Hr.)

Pressure (bar)		Valve Size and Port												
P1	P2	1/2" C	1/2" E	1/2" A	1/2" B	1/2" T	3/4"	1"	1-1/4"	1-1/2"	2"	2-1/2"	3"	4"
0.7	0.3	0.4	1.1	1.8	2.4	2.8	3.8	6.0	10.9	13.7	16.4	38.8	51.4	79.9
	0.2	0.4	1.3	2.0	2.6	3.2	4.3	6.7	12.2	15.3	18.3	43.4	57.5	89.3
1	0.7	0.3	1.0	1.6	2.0	2.5	3.3	5.2	9.5	11.8	14.2	33.6	44.5	69.2
	0.5	0.4	1.3	2.0	2.6	3.2	4.3	6.7	12.2	15.3	18.3	43.4	57.5	89.3
	0.25	0.5	1.6	2.5	3.2	3.9	5.2	8.2	15.0	18.7	22.5	53.2	70.4	109.3
1.5	1	0.4	1.3	2.0	2.6	3.2	4.3	6.7	12.2	15.3	18.3	43.4	57.5	89.3
	0.7	0.5	1.6	2.6	3.3	4.0	5.4	8.5	15.5	19.3	23.2	54.9	72.7	112.9
	0.3	0.7	2.0	3.1	4.1	4.9	6.6	10.4	18.9	23.7	28.4	67.3	89.0	138.3
2	1.5	0.4	1.3	2.0	2.6	3.2	4.3	6.7	12.2	15.3	18.3	43.4	57.5	89.3
	1	0.6	1.8	2.9	3.7	4.5	6.1	9.5	17.3	21.6	25.9	61.4	81.3	126.3
	0.4	0.8	2.3	3.6	4.7	5.7	7.7	12.0	21.9	27.3	32.8	77.7	102.8	159.7
3	2	0.6	1.8	2.9	3.7	4.5	6.1	9.5	17.3	21.6	25.9	61.4	81.3	126.3
	1.5	0.7	2.2	3.5	4.6	5.5	7.4	11.7	21.2	26.5	31.8	75.2	99.6	154.6
	0.6	0.9	2.8	4.4	5.8	7.0	9.4	14.7	26.8	33.5	40.2	95.1	125.9	195.6
3.5	3	0.4	1.3	2.0	2.6	3.2	4.3	6.7	12.2	15.3	18.3	43.4	57.5	89.3
	2	0.7	2.2	3.5	4.6	5.5	7.4	11.7	21.2	26.5	31.8	75.2	99.6	154.6
	1.5	0.9	2.6	4.0	5.3	6.4	8.6	13.5	24.5	30.6	36.7	86.8	115.0	178.6
	0.7	1.0	3.0	4.8	6.2	7.5	10.1	15.9	28.9	36.2	43.4	102.7	136.0	211.3
4	3.5	0.4	1.3	2.0	2.6	3.2	4.3	6.7	12.2	15.3	18.3	43.4	57.5	89.3
	3	0.6	1.8	2.9	3.7	4.5	6.1	9.5	17.3	21.6	25.9	61.4	81.3	126.3
	2	0.9	2.6	4.0	5.3	6.4	8.6	13.5	24.5	30.6	36.7	86.8	115.0	178.6
	0.8	1.1	3.2	5.1	6.7	8.0	10.8	17.0	30.9	38.7	46.4	109.8	145.4	225.9
5	4	0.6	1.8	2.9	3.7	4.5	6.1	9.5	17.3	21.6	25.9	61.4	81.3	126.3
	3	0.9	2.6	4.0	5.3	6.4	8.6	13.5	24.5	30.6	36.7	86.8	115.0	178.6
	2	1.0	3.1	4.9	6.4	7.8	10.5	16.5	30.0	37.4	44.9	106.3	140.8	218.7
	1	1.2	3.6	5.7	7.4	9.0	12.1	19.0	34.6	43.2	51.9	122.8	162.6	252.5
6	5	0.6	1.8	2.9	3.7	4.5	6.1	9.5	17.3	21.6	25.9	61.4	81.3	126.3
	3	1.0	3.1	4.9	6.4	7.8	10.5	16.5	30.0	37.4	44.9	106.3	140.8	218.7
	1.2	1.3	4.0	6.3	8.1	9.9	13.3	20.8	37.9	47.4	56.8	134.5	178.1	276.6
8	6	0.9	2.6	4.0	5.3	6.4	8.6	13.5	24.5	30.6	36.7	86.8	115.0	178.6
	5	1.0	3.1	4.9	6.4	7.8	10.5	16.5	30.0	37.4	44.9	106.3	140.8	218.7
	1.6	1.5	4.6	7.2	9.4	11.4	15.3	24.1	43.8	54.7	65.6	155.3	205.6	319.4
10	8	0.9	2.6	4.0	5.3	6.4	8.6	13.5	24.5	30.6	36.7	86.8	115.0	178.6
	5	1.4	4.1	6.4	8.3	10.1	13.5	21.3	38.7	48.3	58.0	137.3	181.8	282.3
	2	1.7	5.1	8.1	10.5	12.7	17.1	26.9	48.9	61.1	73.4	173.7	229.9	357.1
12	10	0.9	2.6	4.0	5.3	6.4	8.6	13.5	24.5	30.6	36.7	86.8	115.0	178.6
	8	1.2	3.6	5.7	7.4	9.0	12.1	19.0	34.6	43.2	51.9	122.8	162.6	252.5
	5	1.6	4.8	7.6	9.8	11.9	16.0	25.2	45.8	57.2	68.6	162.4	215.1	334.0
	2.3	1.9	5.7	8.9	11.6	14.0	18.9	29.6	53.9	67.3	80.8	191.2	253.2	393.2
14	10	1.2	3.6	5.7	7.4	9.0	12.1	19.0	34.6	43.2	51.9	-	-	-
	5	1.8	5.4	8.6	11.2	13.5	18.2	28.5	51.9	64.9	77.8	-	-	-
	2.7	2.0	6.1	9.6	12.5	15.1	20.3	32.0	58.1	72.7	87.2	-	-	-
15	12	1.0	3.1	4.9	6.4	7.8	10.5	16.5	30.0	37.4	44.9	-	-	-
	5	1.9	5.7	9.0	11.8	14.2	19.1	30.1	54.7	68.4	82.0	-	-	-
	2.9	2.1	6.3	9.9	12.9	15.6	21.1	33.1	60.2	75.2	90.2	-	-	-
17	14	1.0	3.1	4.9	6.4	7.8	10.5	16.5	30.0	37.4	44.9	-	-	-
	10	1.6	4.8	7.6	9.8	11.9	16.0	25.2	45.8	57.2	68.6	-	-	-
	5	2.1	6.3	9.9	12.9	15.6	21.0	33.0	59.9	74.9	89.9	-	-	-
	3.2	2.2	6.7	10.6	13.8	16.7	22.5	35.3	64.2	80.3	96.4	-	-	-
20	17	1.0	3.1	4.9	6.4	7.8	10.5	16.5	30.0	37.4	44.9	-	-	-
	14	1.5	4.4	7.0	9.1	11.0	14.8	23.3	42.4	53.0	63.5	-	-	-
	3.9	2.4	7.3	11.5	14.9	18.0	24.3	38.2	69.4	86.7	104.1	-	-	-
27	24	1.0	3.1	4.9	6.4	7.8	10.5	16.5	30.0	37.4	44.9	-	-	-
	20	1.6	4.8	7.6	9.8	11.9	16.0	25.2	45.8	57.2	68.6	-	-	-
	5.2	2.8	8.5	13.3	17.4	21.0	28.3	44.4	80.8	100.9	121.1	-	-	-

KOMBAT WATER CAPACITY TABLE

- It is recommended to keep valve outlet velocity below 30,000 ft./min.
- Capacities based on maximum Cv.