

# PIPING SPECIALTIES

Nicholson manufactures a wide range of piping specialties to suit a broad spectrum of applications.

- Big Block UMTVS-BB
- STV Test & Block Valve
- Noise Diffuser
- Pneumatic Muffler

Nicholson innovations set the standard.

# BIG BLOCK UMT VALVE STATION

Pressures To 1440 PSIG  
Temperatures to 750°F

## Applications

- Unit Heaters
- Steam Tracing
- Drip Legs
- Heating
- Tire Presses
- Cooking Equipment
- Laundry Equipment
- Plating Tanks
- Patent Presses
- Refinery
- Process

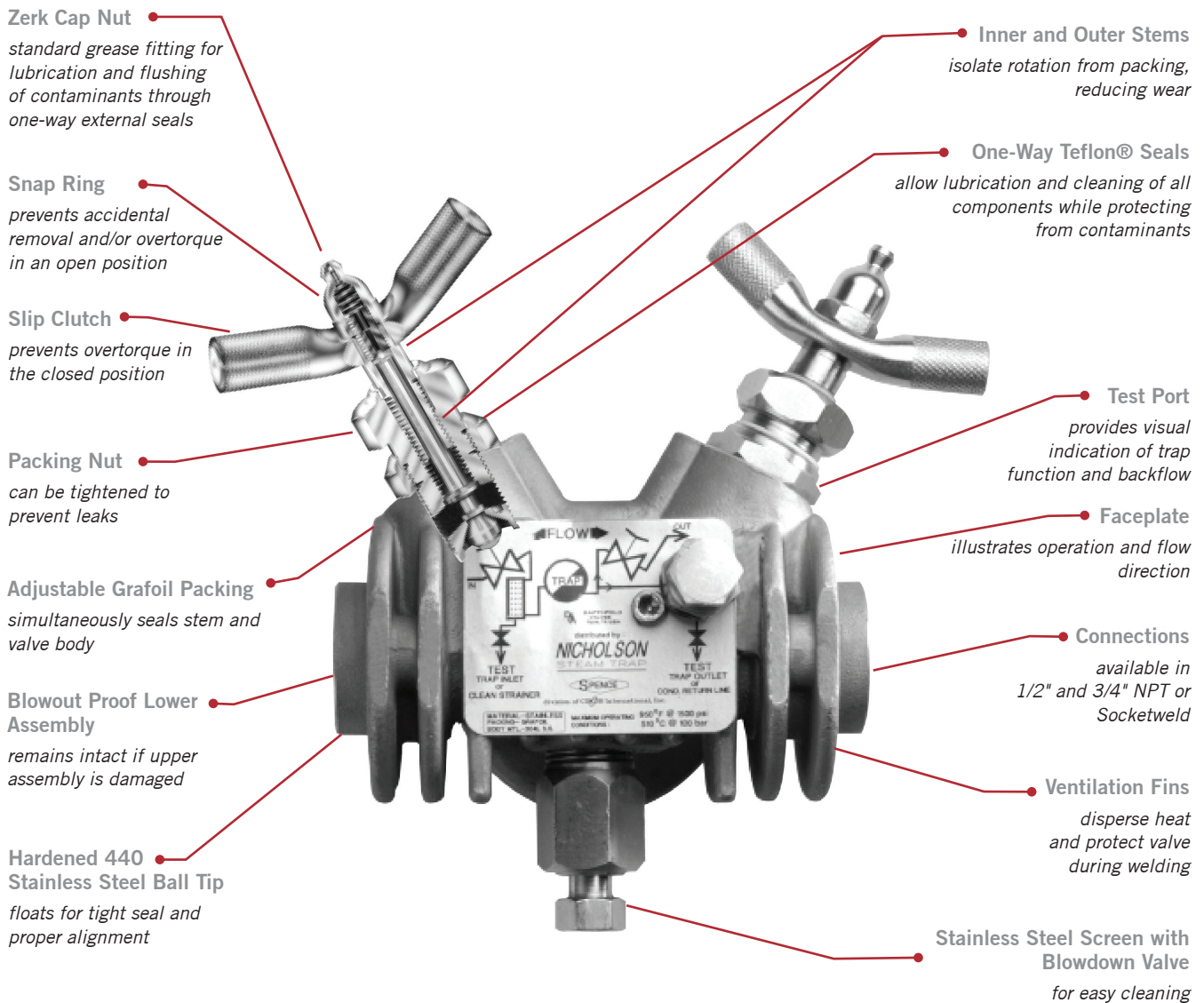

Minimum 1/4" Ports Throughout  
assures high flow capacity

Compact Size  
for easy installation

# BIG BLOCK

## UNIVERSAL MOUNT TRAP VALVE STATION

Pressures to 1440 PSIG (99 bar)  
Temperatures to 750°F (399°C)

**Compact Size** - Isolation valves, test ports, strainer and blowdown valve combined in one “Big Block” for easy installation.

**Universal Mount** - Universal two bolt swivel trap mount installs permanently into system, simplifying installation and removal of trap.

**Highest Pressure and Temperature Ratings** - Suitable for virtually all applications.

**All Stainless Steel** - Body, internal wetted parts and polished inner stem are durable and corrosion resistant.

**Blowout Proof Isolation Valves** - Feature grease fittings to lubricate one way Teflon® seals and flush contaminants. Protected from overtorque.

**Adjustable Grafoil Packing** - Simultaneously seals stem and valve body.

**Inner and Outer Valve Stems** - Reduce wear.

**Hardened 440 Stainless Steel Ball Tip** - provides tight seal and proper alignment.

**High Capacity** - All internal ports at least 1/4".

### MODELS

- UMTVS-BB

### OPTIONS

- SW - Socketweld Connections

### Operation

The UMTVS Big Block may be used in conjunction with any two-bolt universal mount steam trap. It combines a universal mount connector block with isolation valves, strainer, blowdown valves and test port to permit fast and easy testing, maintenance, and repair or replacement of a universal mount steam trap.

#### Integral Strainer and Blowdown Valve

The built-in strainer captures dirt and scale. The blowdown valve at the bottom of the connector block may be used periodically to clean out the strainer.

#### 1st Inlet Isolation Valve (left)

Turning the first isolation valve to the off position (clockwise) stops the flow before it reaches the universal mount steam trap, strainer and blowdown valve. If the first isolation valve is opened (counterclockwise) flow will be directed through the strainer and blowdown valve ports and to the universal mount steam trap.



### Applications

- Unit Heaters
- Steam Tracing
- Drip Legs
- Heating
- Tire Presses
- Cooking Equipment
- Laundry Equipment
- Plating Tanks
- Patent Presses
- Refinery
- Process

### CODES

- Designed per ASME B16.5, Class 600

#### Test port (on face)

Condensate exiting the universal mount steam trap is directed to the test port. Fully open the test port by loosening the larger test port valve located on the face of the block (counterclockwise). This will provide a visual indication of the trap discharge pattern to determine the steam trap functionality.

#### 2nd Outlet Isolation Valve (right)

Turning the second isolation valve to the off position (clockwise) stops the flow to the outlet connection. The flow still may be exhausted through any of the previously mentioned ports. When the second isolation valve is open (counterclockwise), flow to the outlet connection will continue. Downstream backflow discharge may be observed through the open test port by closing the first Inlet Isolation Valve and blowdown valve and opening the second Outlet Isolation Valve.

# BIG BLOCK

## UNIVERSAL MOUNT TRAP VALVE STATION

### SPECIFICATION

Big Block Universal Mount Trap Valve Station shall be a universal mount connector block with integral strainer, blow-down valve, test ports, and dual isolation valves. Body shall be 304L stainless steel. It shall be suitable for pressures to 1440 PSIG. End connections shall be NPT or Socketweld and accommodate connection sizes of 1/2" and 3/4". It shall function in any orientation. It shall accept universal mount steam traps. The isolation valves shall be bonnetless and blowout proof with a relubrication system.

#### Maximum operating conditions

Class 600 -	855 psig	59 barg)
	750°F	399°C)
	1440 psig	(99 barg)
	100°F	(170°C)

#### Materials of construction

Body .....	Investment Cast 304L Stainless Steel**
Blowdown Valve .....	304 Stainless Steel
Strainer .....	304 Stainless Steel .033 Perf
Test Port & Lock Nut.....	303 Stainless Steel
Internal Components .....	Stainless Steel
External Seals .....	Teflon®
Packing .....	Grafoil

\*Per ASME B16.5, Class 600

\*\* Per ASTM A351-CF

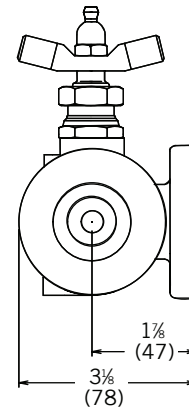
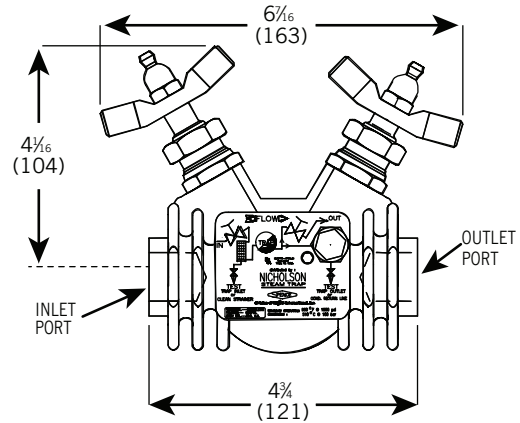

DIMENSIONS - INCHES (MM)  
WEIGHT: 6 LBS. (2.7 KG)

Connections: 1/2" & 3/4" NPT or Socketweld

# STV SERIES

## FLOATING LEVER AIR DRAINER

Pressures To 250 PSIG (17.2 barg)  
Temperatures to 406°F (208°C)

**Visual Steam Trap Test** - Provides for quick visual examination of steam trap discharge.

**Compact Body** - Small size facilitates installation and operation in tight spaces.

**Stainless Steel Internals** - High quality materials provide long service life and protection against corrosion.

**Repairable** - All parts are easily replaceable.

**Large Size Test Vent** - Vent passage in ball is large enough to provide true determination of trap discharge.

**Safety Designed** - Bottom loaded, pressure retaining stem and packing nut threaded to body provides extra margin of safety.

**Reduces Labor Costs** - Eliminates need to install and maintain separate blocking and test valves.

**Minimizes Risk of Connection Leaks** - Eliminates the need for numerous fittings.

### Applications

---

- Test Steam Traps
- Sample Fluids or Gases from Process Lines

### OPTIONS

---

- Stainless Steel Latch-lok Handle

Canadian Registration # OCO591.97



### Operation

---

STV test/block valve is installed on downstream side of steam trap. During normal operation, valve is in open position with unrestricted flow through trap into the return system.

One quarter turn (90°) of STV blocks flow from return and vents trap discharge to atmosphere. Provides quick, visual check of trap operation.

# STV SERIES

## COMBINATION TRAP TEST & BLOCKING STEAM VALVE

### Maximum operating conditions

PMO: Max. Operating Pressure	250 psig	(17 barg)
TMO: Max. Operating Temperature	406°F	208°C)
PMA: Max. Allowable Pressure	250 psig	(17 barg)
TMA: Max. Allowable Temperature	406°F	(208°C)

### Materials of construction

Body:	ASTM A216 WCB Carbon Steel (Blk oxide & oil coat)
Adapter:	12L14C.R.S. (Blk oxide & oil coat)
Ball:	316 Stainless Steel
Seat:	25% Mineral Fill Virgin Teflon
Stem:	316 Stainless Steel
Insulator:	Plastisol (Vinyl grip)
Packing Gland:	Carbon Reinforced Teflon
Packing Nut:	12L14 C.R.S. (Blk oxide & oil coat)
Handle Nut:	Steel (Zinc plated)
Handle:	11 Ga. C.R.S. (Zinc plated)
Thrust Washer:	Glass Reinforced Teflon
Body Seal:	Virgin Teflon

Size	Inches (mm)							Weight Lbs. (kg)
	A	B	C	D	E	F	G	
½" (15)	.375 (10)	.156 (4)	.281 (7)	2.26 (57)	1.20 (30)	2.17 (55)	4.25 (108)	1.1 (.5)
¾" (20)	.531 (13)	.218 (6)	.281 (7)	2.83 (72)	1.49 (38)	2.45 (62)	4.25 (108)	1.4 (.64)

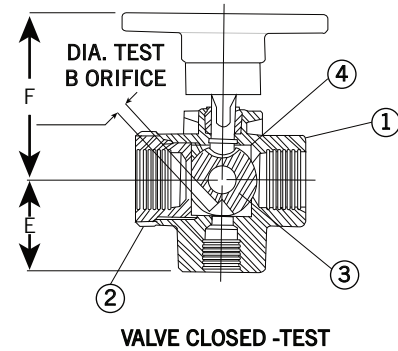
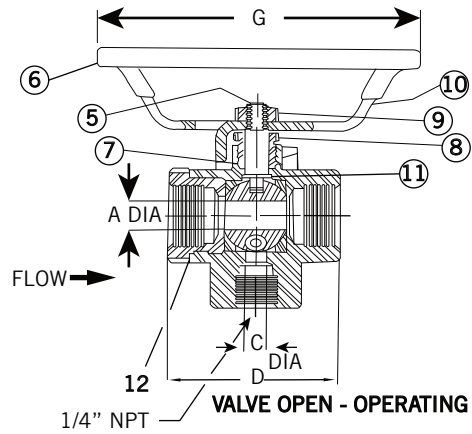

Connections: 1/4" NPT Blowdown 1/2" and 3/4" NPT Inlet & Outlet

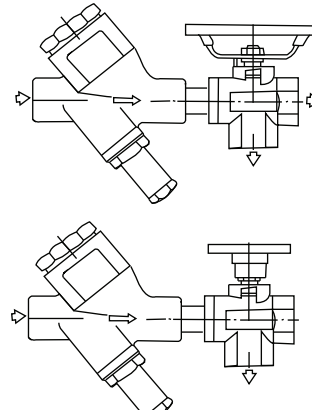

# SS600 SERIES

## NOISE DIFFUSER

Pressures To 600 PSIG (41.3 barg)  
Temperatures to 750°F (400°C)

**Diffuses Blast Discharge** - Diffuses the high velocity discharge from steam traps.

**Reduces Noise** - Dampens the level of noise associated with steam trap cycles.

**Corrosion Resistant** - All stainless steel construction provides excellent protection from corrosion.

**Causes No Back Pressure** - Porous stainless steel baffle allows condensate discharge without back pressure.

**Compressed Air Capabilities** - Diffuser works as a muffler for compressed air exhaust.

**Repairable in-line** - Snap ring design allows for easy element replacement.

### Applications

---

- Steam Traps
- Blowdown Valves
- Air Cylinders

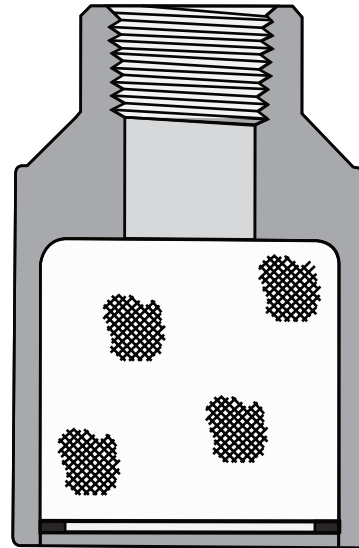

### Operation

---

The SS600 Diffuser is installed on the outlet side of steam traps, valves or other equipment that discharges high velocity steam, condensate or air to the atmosphere. The baffle is constructed of

a fine stainless steel wire mesh, similar to steel wool. This porous mesh breaks down the high velocity discharge which dampens the sound significantly.

# SS600 SERIES NOISE DIFFUSER

## Maximum operating conditions

PMO: Max. Operating Pressure	600 psig	(41.3 barg)
TMO: Max. Operating Temperature	750°F	400°C)
PMA: Max. Allowable Pressure	600 psig	(41.3 barg)
TMA: Max. Allowable Temperature	750°F	(400°C)
TMA: Max. Allowable Temperature	1000 psig	(69 barg)

## Materials of construction

Body: .....ASTM A351 Grade CF3M (316L)  
 Retaining Ring: .....302 Stainless Steel  
 Element: .....304Stainless Steel

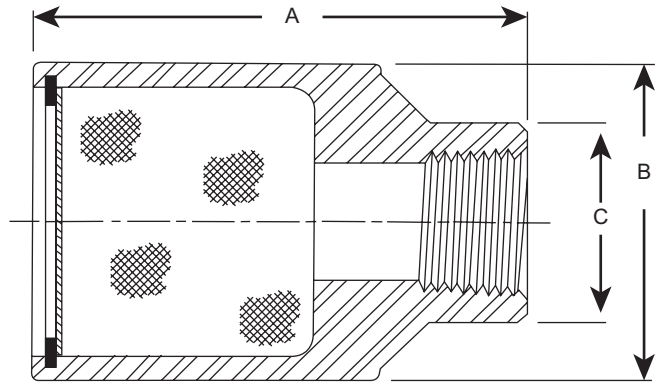

Connections: 3/8" – 3/4" NPT

Dimensions				
NPT Size	Inches (mm)			Weight Lbs. (kg)
	A	B	C	
3/8"	2 3/4	1 25/32	1 1/8	.85 lbs
1/2"	2 3/4	1 25/32	1 1/8	.85 lbs
3/4"	2 25/32	1 25/32	1 5/16	.85 lbs

## Noise Three Feet from Trap Discharge

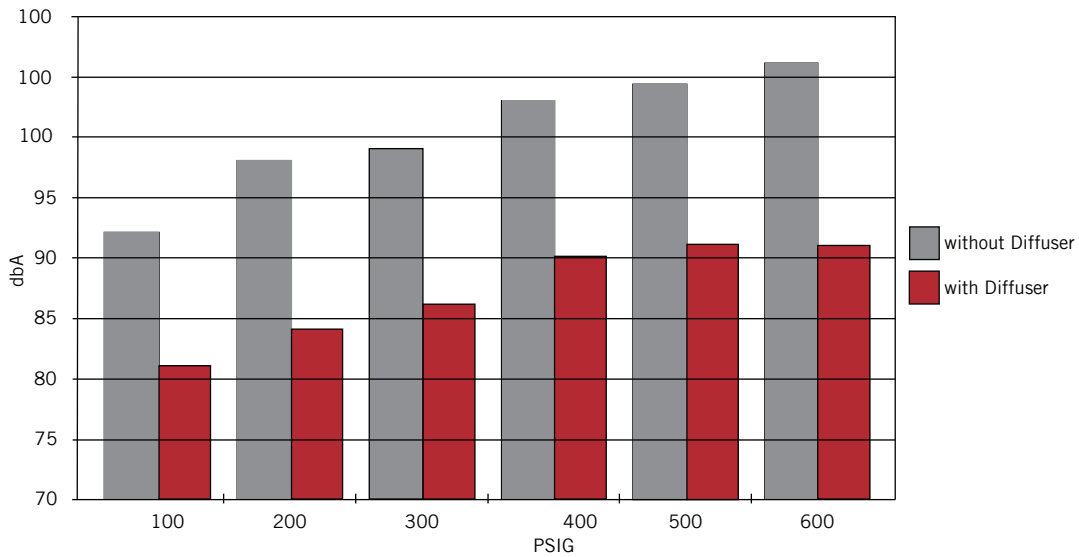



# PNEUMATIC MUFFLERS

Pressures To 600 PSIG (41.4 barg)  
Temperatures to 220°F (104°C)

**Reduces Noise to Acceptable Levels** - Specifically designed to reduce the noise of exhaust.

**Compact and Lightweight** - Adds minimal space and weight to installation.

**Durable Construction** - Will provide years of service.

**Corrosion Proof** - Nylon and felt construction will not corrode in most services.

## Applications

- 2, 3 and 4-way Valves
- Pneumatic Cylinders
- Air Motors
- Air Tools
- Instrumentation
- Bench Fixtures
- Test Panels
- Relief Valves



## Operation

The muffler housing and plug are made of nylon. compressed exhaust air enters the muffler as shown by the flow arrows. It is then diverted by a plastic insert sleeve through a packing of sound

deadening felt and out through exit slots. A fine mesh screen shields the felt packing and retains it in position.

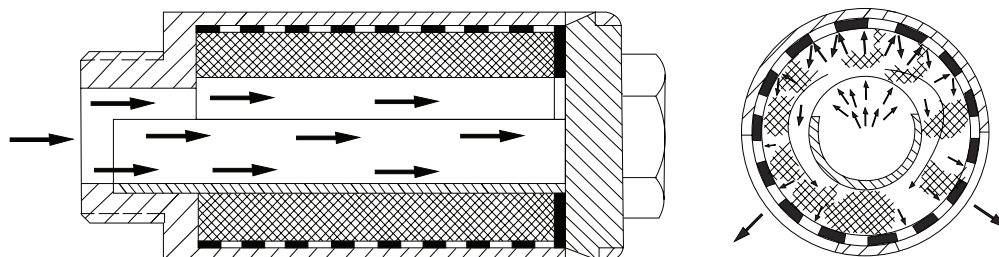

# PNEUMATIC MUFFLERS

## Maximum operating conditions

PMO: Max. Operating Pressure	600 psig	(41.3 barg)
TMO: Max. Operating Temperature	220°F	104°C)
PMA: Max. Allowable Pressure	600 psig	(41.3 barg)
TMA: Max. Allowable Temperature	220°F	(104°C)

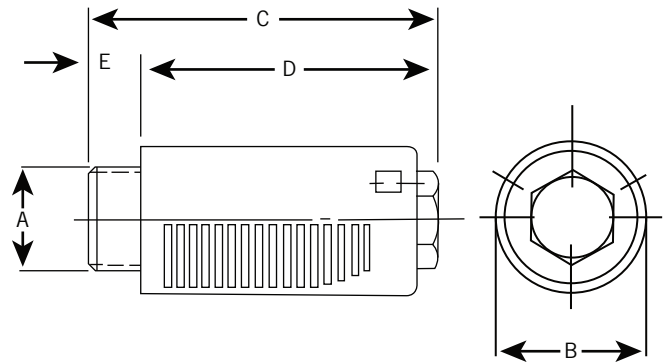

Connections: 1/8" – 1/2" NPT

## Materials of construction

Housing: .....Nylon  
 Screen .....Aluminum  
 Media: .....Felt

A NPT Size	Dimensions			
	Inches (mm)			
	B	C	D	E
1/8"	.63	1.72	1.38	.34
1/4"	.83	2.06	1.66	.40
3/8"	.99	2.43	2.03	.40
1/2"	1.18	2.90	2.37	.53

## AIR FLOW AND SOUND MEASUREMENTS OF NICHOLSON PNEUMATIC MUFFLERS

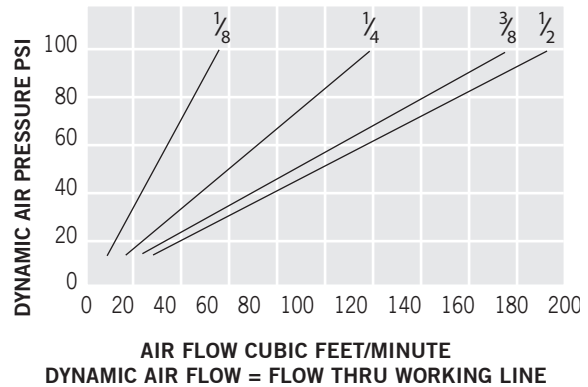
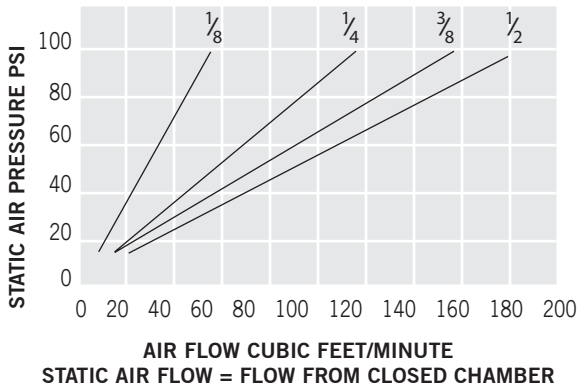

## SOUND LEVELS ON A WEIGHING SCALE

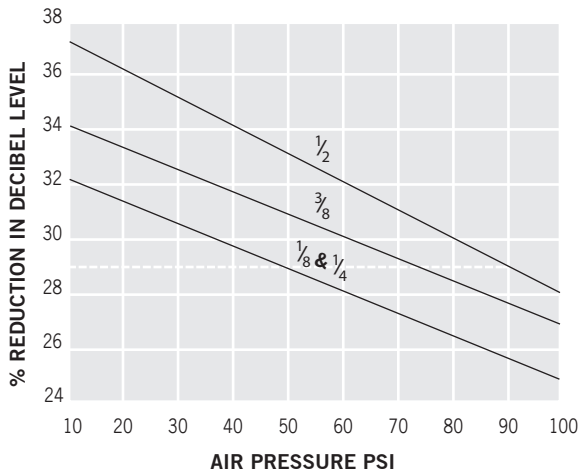

## USING GRAPH

Condition: Exhaust of air at 90 PSI produces a noise level of 100 dbA. Noise must be reduced to an acceptable level.

Solution: 1/2" Muffler will reduce level 29%. Muffled discharge will be at 71 dbA.